

# ***SawStop***<sup>®</sup>

## **Quick Start Guide**

---

10" Contractor Saw

## What are you cutting?

Run the saw in **Normal Mode** to cut non-conductive materials like wood, plastic, cardboard, foam, Corian, melamine and dry pressure-treated wood.

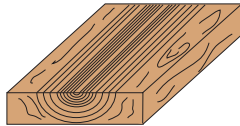

For **Normal Mode** go to page **3**.

Run the saw in **Bypass Mode** to cut conductive materials like metal, very wet or very green wood, Carbon-filled materials, mirrored acrylic, carbon fiber materials and wet pressure-treated wood.

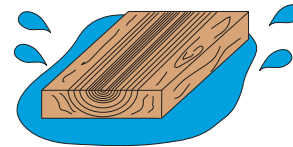

For **Bypass Mode** go to page **4**.

### Not Sure?

If you don't know whether the material you are about to cut is conductive, perform the material conductivity test on page 5.

## To Run Saw in Normal Mode:

1. Flip the main power switch up to turn on power.

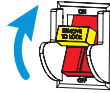

2. Wait until the green light is on steady and the red light is off.



3. Pull the Start/Stop Paddle out to spin the blade.



4. Push the Start/Stop Paddle in to stop the blade.

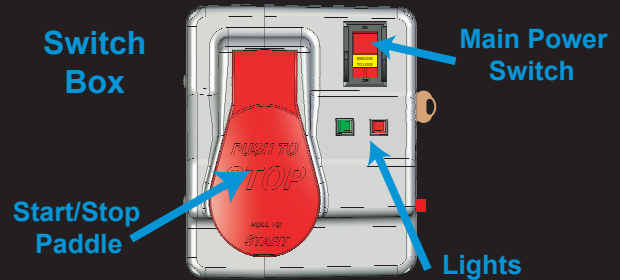

**⚠ WARNING:**  
Do not touch the blade while the blade is coasting down. Your touch will activate the brake.

5. If you are finished using the saw, flip the main power switch off after the blade has come to a complete stop.

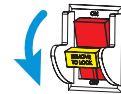

**⚠ WARNING:**  
Always turn off the main power switch and unplug the saw before changing the blade or performing any maintenance.

## To Run Saw in **Bypass Mode**:

1. Flip the main power switch up to turn on power.



2. Wait until the green light is on steady and the red light is off.



3. Turn the bypass key clockwise and hold.



4. Hold the bypass key turned for 2 seconds, pull out the Start/Stop Paddle, and hold the key 2 more seconds.

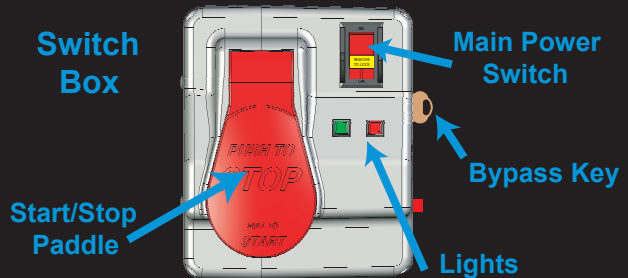
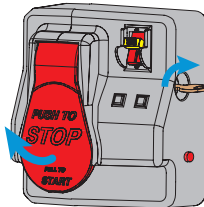

5. Release the key. The green light blinks slowly and the red light is off when in Bypass Mode.



6. Push the Start/Stop Paddle in to stop the blade. The saw exits Bypass Mode after the blade has come to a complete stop.



### **⚠ WARNING:**

Only use Bypass Mode to cut conductive material or to test material conductivity. There is no protection in Bypass Mode.

## Material Conductivity Test

Perform the following test if you don't know whether the material you want to cut is conductive.

1. Start the saw in Bypass Mode.
2. *Carefully* make several cuts of the material.
3. Check the red light before pushing in the Start/Stop Paddle.

If the red light blinks fast, the material is conductive.



If the red light is off, the material is non-conductive.



## WHAT TO DO if the brake **ACTIVATES** ...

1. Turn OFF the saw and unplug the power cord.
2. If the blade retracted, turn the elevation handwheel **fully** counter-clockwise and then fully clockwise to raise the blade.
3. Change the brake cartridge -- see page 12.
4. Change the blade -- see page 10.
5. Adjust the blade-to-brake spacing -- see page 11.

**After performing these steps, the saw is ready for operation.**

? See Owner's Manual p.57

# Switch Box Lights



The red and green lights on the switch box tell you if the saw is operating normally or if there is a problem. Each light may be **OFF**, or it may be **ON** solid, **ON** blinking slowly, or **ON** blinking quickly. After system startup, the red light goes on when there is a problem. Find the matching pattern below to identify the problem.

Green light   Red light



**System Startup** - The system is performing self-checks. Allow 10 seconds to clear.



**System Ready** - The saw is ready to run or is running in Normal mode.



**Replace Cartridge** - Turn the main power switch OFF and then ON again. If this error does not clear, replace the brake cartridge (see page 12).



**Coasting Down** - **DO NOT TOUCH THE BLADE.** The brake will activate if contact is detected during coast-down.



**Bypass Mode ON** - The saw is in Bypass Mode. **The safety brake will not activate in Bypass Mode.**



**Push the Start/Stop Paddle to OFF** - The saw will not start if the paddle is pulled out when the main power switch is turned on.



**Turn the Cartridge Key to ON** - Turn the main power switch OFF and reinstall the cartridge key, turning it *fully* 90 degrees (see page 13).



**No Blade Rotation** - Make sure the power cable to the motor is connected and the belt is installed. Press the thermal reset button on the switch box.



**Adjust Brake Cartridge Position** - Turn the main power switch OFF and check the blade-to-brake spacing (see page 11).



**Contact Detected During Standby** - Contact was detected while the blade was stopped. Wait 5 seconds for this code to clear.



**Contact Detected During Bypass** - Contact was detected during bypass mode. This code will clear when the blade stops.



**Overload Due to Wet Wood** - The wood being cut is too wet or too green. To clear, push the paddle in and turn the main power switch OFF and then ON again. Allow the wood to dry before cutting or cut the wood in Bypass Mode.

? See Owner's Manual pp.39-41

# Table Insert

## To Remove the Table Insert:

1. Turn the saw OFF and unplug the power cord.
2. Set the blade to 0° and raise it fully.
3. Remove the front lock-down screw.

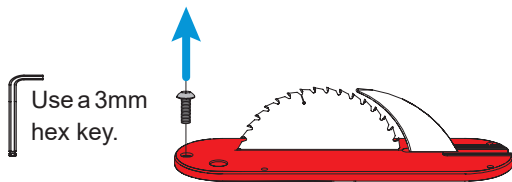

4. Lift the table insert at a slight angle and pull it away from blade.

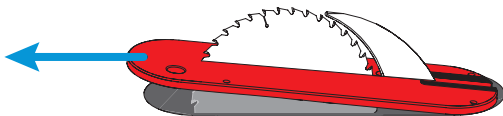

## To Install the Table Insert:

3. Slide the table insert toward the blade at a slight angle.

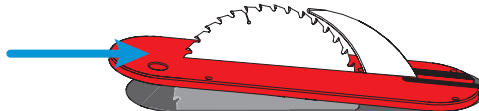

The screws in the bottom rear of the insert should slide under the heads of the screws in the rear of the table opening.

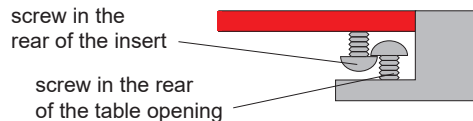

4. Install the front lock-down screw.

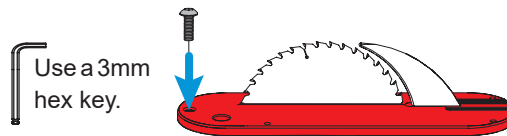



## Changing the Riving Knife / Blade Guard

1. Turn the saw OFF and unplug the power cord.
2. Set the blade to 0°, raise it fully and remove the table insert.
3. Reach into the table opening and lift the clamping handle fully upward.

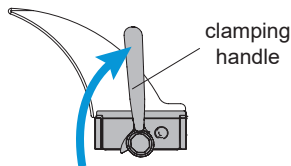

4. Remove the riving knife or blade guard.

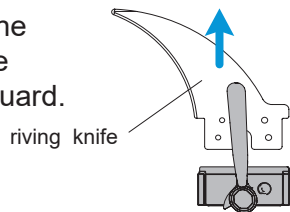

5. Position the blade guard or riving knife in the clamp.

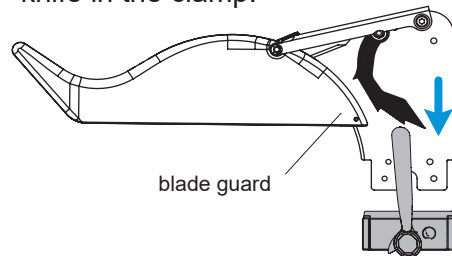

6. Fully lower the clamping handle.

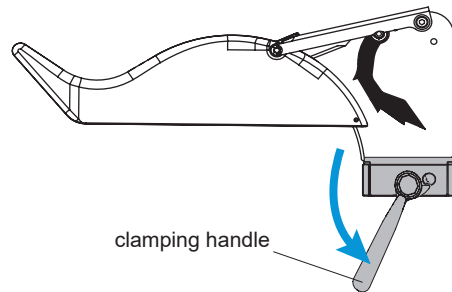

? See Owner's Manual pp.30-31, 42-43

## Changing the Blade

1. Turn the saw OFF and unplug the power cord.
2. Set the blade to 0°, raise it fully and remove the table insert.
3. Remove the blade nut and washer. Place the open end of one blade wrench on the flat sides of the arbor. Place the closed end of the other wrench over the nut. Turn the nut **counter-clockwise** to loosen.

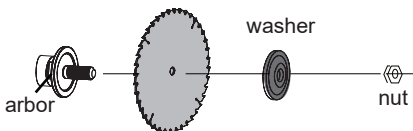

 **WARNING:**  
Never install the blade backwards.

4. Install the blade with the teeth pointing forward (as shown).  
*Note: If you are installing a dado set, first install a dado brake cartridge.*
5. Install the washer and the nut for a 10" blade; install the nut without the washer for dado sets over 1/4" thick. Using the wrenches, turn the nut **clockwise** to tighten.
6. **YOU ARE NOT DONE.** You must now check the blade-to-brake spacing (see page 11).



 See Owner's Manual p.27

# Adjusting the Blade-to-Brake Spacing

Always adjust the blade-to-brake spacing after installing a blade or brake cartridge.

1. Turn the saw OFF and unplug the power cord.
2. Remove the table insert.
3. Place the yellow spacing gauge between the blade and the brake as shown (or use a nickel instead).  
The gauge should just fit between the blade and the brake.
4. To **DECREASE** the spacing, turn the yellow bolt **CLOCKWISE**.  
To **INCREASE** the spacing, turn the bolt **COUNTER-CLOCKWISE**.  
(Use the 8 mm hex key included with saw.)
5. With the saw off, spin the blade by hand two full revolutions to make sure no tooth touches the brake.

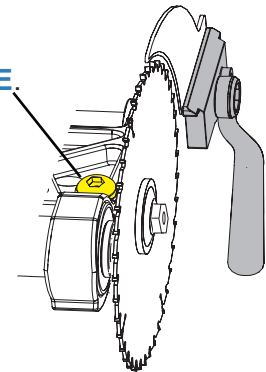
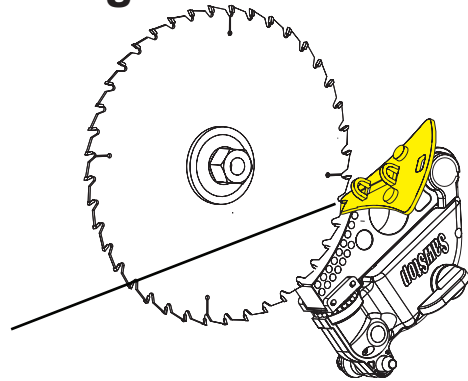

? See Owner's Manual pp.28-29

# Changing the Brake Cartridge

1. Turn the saw OFF and unplug the power cord.
2. Set the blade to 0°, raise it fully and remove the table insert.
3. Lift the clamping handle fully upward.

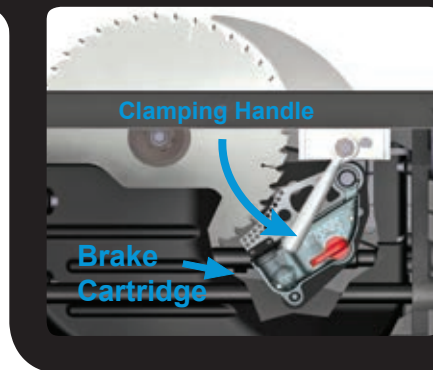

## TO REMOVE THE CARTRIDGE:

4. Turn the cartridge key *fully* 90° clockwise and pull it out.
5. If the brake has not activated, pull the cartridge off the mounting pins.

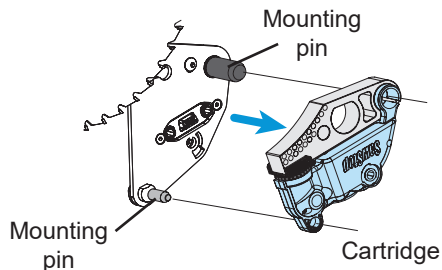
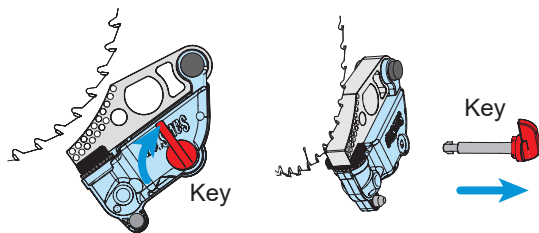

? See Owner's Manual pp.53-55

**If the brake has activated, remove the brake and blade together** by “walking” the blade and brake off the arbor and mounting pins. To “walk” them off, alternately pry the blade and then the brake out a short distance at a time using a blade wrench.

#### TO INSTALL THE CARTRIDGE:

- 4.** Slide the cartridge onto the mounting pins until it is fully seated.

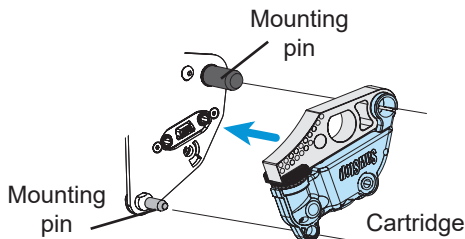

- 5.** Insert the cartridge key with the red handle pointing up. Rotate the key *fully* 90° counter-clockwise.

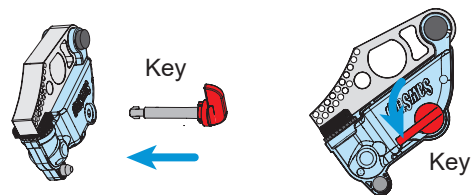

- 6.** Lower the clamping handle fully downward.
- 7.** Check the blade-to-brake spacing -- see page 11.

 See Owner's Manual pp.55-56

